

# WBH Series

## WBH 2525



8.7 l/m  
2.3 USGPM



max 175 BAR  
2500 P.S.I.

### APPLICAZIONI - APPLICATIONS



MANUTENZIONE  
MAINTENANCE



PROCESSI INDUSTRIALI  
INDUSTRIAL PROCESSES



AUTOLAVAGGIO  
CARWASH



EDILIZIA  
CONSTRUCTION



SANIFICAZIONE  
SANITIZATION

### TECHNICAL PLUS:



USCITA ALBERO DX  
RIGHT DRIVE SHAFT



CARTER REVERSIBILE, PER USCITA ALBERO SX O DX  
REVERSIBLE CRANKCASE FOR LEFT OR RIGHT



BIELLE IN LEGA TONOLLI 328  
CONRODS IN HYPER 328 TONOLLI ALLOY



GUARNIZIONI TENUTA ACQUA NBR (BUNA)  
NBR (BUNA) WATER SEALS

### OPTIONAL:



USCITA ALBERO LATO SX  
LEFT DRIVE SHAFT



BIELLE IN BRONZO  
BRONZE CONRODS

### GUARNIZIONI - SEALS



GUARNIZIONI ANTERIORI  
"V" - POSTERIORI "U"  
"V" FRONT SEALS - "U" BACK SEALS

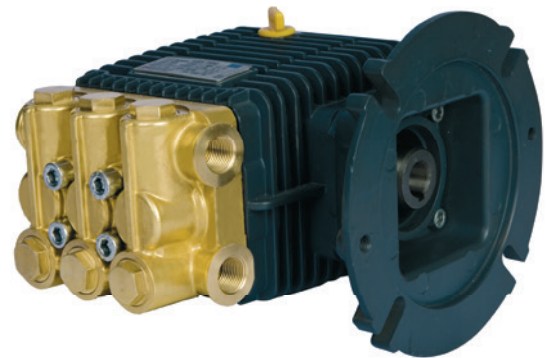
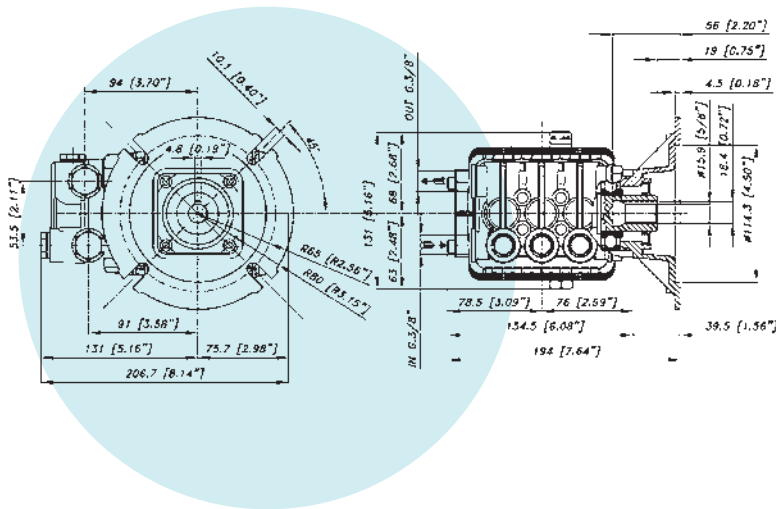

### CARATTERISTICHE TECNICHE SPECIFICATIONS

<b>Peso - Weight</b>	<b>6,1 Kg</b>	13.4 lb
<b>IN</b>	<b>3/8 BSP</b>	
<b>Pressione Min - Min Pressure</b>	<b>-0,1 BAR</b>	-1.5 P.S.I.
<b>Pressione Max - Max Pressure</b>	<b>6 BAR</b>	87 P.S.I.
<b>OUT</b>	<b>3/8 BSP</b>	
<b>Albero - Shaft</b>	<b>HOLLOW Ø 5/8"</b>	
<b>Max. Temperatura - Max. Temperature</b>	<b>60 °C</b>	140 °F
<b>Tipo olio - Oil type</b>	<b>SAE 75 - W 90</b>	
<b>Capacità olio - Oil capacity</b>	<b>0,5 lt</b>	0.13 U.S.G.
<b>Predisposta per motore - For Motor</b>	<b>NEMA 56C-5/8"</b>	



CODICE CODE	MODELLO MODEL	Press. Max Max Pres.		RPM 1725				Pist. Plung.	Corsa Stroke
				Portata-Flow		Potenza-Power			
		BAR	P.S.I.	L/min	GPM	KW	HP	Dia. mm	mm
02.6100.97.3	WBH 1520	105	1500	7,6	2	1,5	2	18	6
02.6101.97.3	WBH 1920	130	1900	7,6	2	1,8	2,5	18	6
02.6102.97.3	WBH 1525	105	1500	8,7	2,3	1,8	2,4	18	7,2
02.6103.97.3	WBH 1925	130	1900	8,7	2,3	2,2	3	18	7,2
02.6104.97.3	WBH 2525	175	2500	8,7	2,3	2,9	3,9	18	7,2
02.6105.97.3	WBH 1530	105	1500	10,4	2,8	2,1	2,8	18	8,6
02.6106.97.3	WBH 2130	145	2100	10,4	2,8	2,9	3,9	18	8,6
02.6107.97.3	WBH 1432	95	1400	12	3,1	2,2	3	18	9,8
02.6108.97.3	WBH 1932	130	1900	12	3,1	3	4	18	9,8